

McGrath

PEST AND BUILDING PRE-PURCHASE REPORTS

DISCLAIMER:

This Disclaimer governs the use of the attached Pest and Building Reports.

By using this report, the reader accepts this Disclaimer in full and acknowledges the reports have been commissioned by the vendor for the purpose of marketing the property for sale.

McGrath Estate Agents does not guarantee or warrant the accuracy, reliability, completeness or currency of the information in these reports. Readers are responsible for assessing the relevance and accuracy of the content of these reports and obtaining the advice of an independent, appropriately qualified professional.

Inspection Report

Provided By



Naraic Building & Pest Inspections Pty Ltd

PO Box 1563, Kingscliff, New South Wales, 2487

P 0404071171

michael@naraic.com.au

www.naraicbuildingpestinspection.com.au

Inspection Address

36 Gibbon St, Lennox Head, NSW, 2478



Report Information

Client Information

Client Name	Vendor - McGrath Lennox Head
Report Ordered By	Vendor - McGrath Lennox Head
Email	ToriWood@mcgrath.com.au

Inspection Information

Report/Agreement #	100924012943422
Inspection Date:	10 Sep 2024
Inspection Time:	01:30 PM

Pest And Building Inspection

The Scope of the Inspection: This report Complies with Australian Standards AS 4349.1-2007. Inspection of Buildings Part 1: Pre- Purchase Inspections-Residential Buildings- Appendix "C" and with AS 4349.3-2010 (Visual Timber Pest Inspection Report)

Only the purchaser name at the front page of the report "Client" should rely on this report. If this report has been issued to you by a third party. You are not to rely on its findings or contents and seek to obtain your own independent pre purchase inspection report as this report or its contents is non transferable. The inspection WILL NOT report on items listed in Appendix "D" of AS43491.2007.

If the property is part of a Strata or Company Title , then Appendix "B" of the Australian Standards applies.

Special Requirements: Unless stated otherwise in the report It is acknowledged that there are no special requirements placed on this inspection that are outside the scope of the abovementioned Australian Standard.

Inspection Agreement: This report is subject to the terms, scope, description and limitations of the inspection agreement that was entered into prior to the inspection being performed. (Note: This agreement may have been entered into by your Solicitor/Conveyancer or other agent). If you are unsure in any way as to how that inspection agreement impacts this inspection and report, please seek clarification prior to committing to the property.

Changes to the Inspection Agreement: Unless stated otherwise in the report It is acknowledged that if any inspection agreement is in place in respect to this inspection, no changes have been made between the scope of the pre-Inspection Agreement and the scope of this inspection report.

Please read the entire report. Refer to the terms & conditions as they form part of the report

Areas to be Inspected and Restrictions

The Building and the site including fencing that is up to 30 meters from the building and within the boundaries of the site. Where present and accessible, the Inspection shall include.

- (a) The interior of the building.
- (b) The roof space.

- (c) The exterior of the building
- (d) The sub-floor space
- (e) The roof exterior
- (f) The property within 30 m of the building subject to inspection.

















Visual Inspection Only

This is a visual inspection only limited to those areas and sections of the property fully accessible and visible to the inspector on the date of inspection. The inspection did not include breaking apart, dismantling, removing or moving objects including, but not limited to, foliage, mouldings, roof insulation/ insulation, floor or wall coverings, sidings, ceilings, floors, furnishings, appliances or personal possessions. The inspector cannot see inside walls, between floors, inside skillion roofing, behind stored goods in cupboards and other areas that are concealed or obstructed. The inspector did not dig, gouge, force or perform any other invasive procedures. Visible timbers cannot be destructively probed or hit without the written permission of the property owner.

Very Important note to the purchaser.

In the event that areas where access could not be gained ie: locked areas or rooms where physical access could not be gained, structural defects, termite damage or activity may be present but not seen. Access should be provided and a follow up or re-Inspection should be undertaken prior to a contract of sale becoming binding. Please consult with the vendor and request full access to restricted areas. This should be done prior to a decision to purchase.

Table of Contents

	1. SITE		9. KITCHEN & LAUNDRY
	2. ROOF AND GUTTER		10. ROOF VOID
	3. HOT WATER SYSTEM		11. CONCLUSION
	4. EXTERIOR		12. PROPERTY AND INSPECTION INFORMATION
	5. GARAGE - CARPORT		13. ACCESS AND RESTRICTIONS
	6. STAIRS- PERGOLA- BALCONIES-DECKS		14. TIMBER PEST FINDINGS
	7. INTERIORS		15. CONDUCTIVE CONDITIONS
	8. BATHROOM(S)		16. OVERALL ASSESSMENT



SITE

Driveway

Materials

The driveway is concrete.

Driveway Condition

On visual inspection, the general condition of the driveway is serviceable.



Paths

Pathways Condition

The paths around the home are in a serviceable condition for the age of this dwelling with no major defects visible.

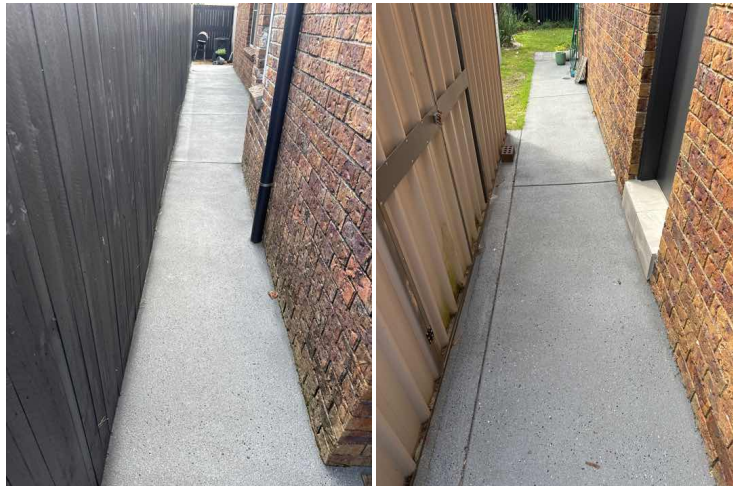

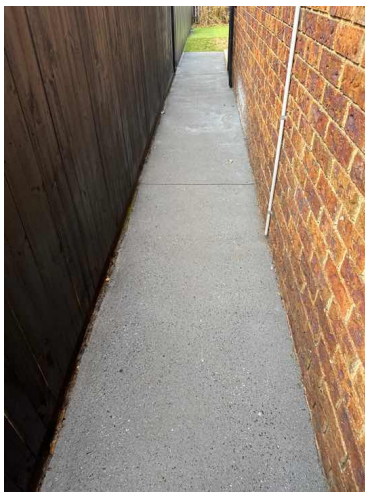

Fences & Gates

Overall Condition

Of the visible areas, the general condition of the fences and gates is serviceable for the age of dwelling.



Surface Drainage

Drainage Findings

There was no visible evidence of excess ponding or fall towards the property walls at the time of the inspection. Regardless, it is difficult to ascertain in dry conditions and it is therefore recommended that you assess same after a rainfall period to be able to sufficiently ascertain if any problems exist in this regard. If water is ponding around perimeter walls and paths or appears to be flowing into the footings/foundations you must have assessed by a qualified plumber or landscaper.

Drains

Recommend installing a drainage point under the tap to assist with drainage.

Shed

Shed Condition

The shed is in fair usable condition.



Trees

Tree Findings

Trees are close to the dwelling. These currently do not appear to have caused any defects/wall cracking. Recommendations: Engage a qualified arborist to carry out an assessment on potential issues.



ROOF AND GUTTER

Roof Covering

General Disclaimer

Refer to Section 2C of the Terms And Conditions section of this report

Roof Covering Type

The roof is of concrete tiles.

Overall Condition

Of the visible areas, the general condition of the roof is in serviceable condition for the age.

Note: In the absence of rainfall there is no guarantee that the roof won't leak.

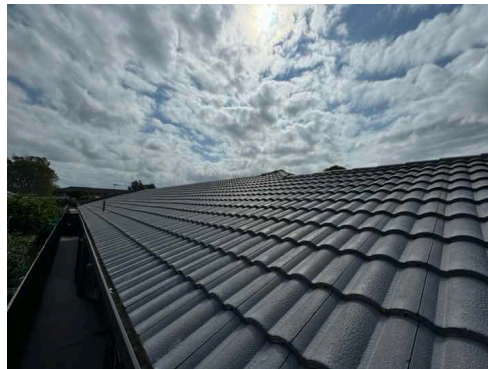

Guttering

Gutter Findings

All visible and accessible of the physical nature of the guttering system appears to be in a serviceable condition with no apparent defects at the time of inspection. In the absence of prolonged rain fall efficiency of the guttering can not be assessed and you may find that further investigation or repairs maybe required. Note: Periodic maintenance checks should be carried out for rust penetrations and leaks.



Downpipes

Downpipe Findings

On visual inspection no apparent defects were noted to the down pipes and are considered serviceable, however no comment can be made with regard to blockages or connections to stormwater or functionality in the absence of rain. Note: Periodic maintenance checks should be carried out for rust penetrations and leaks.

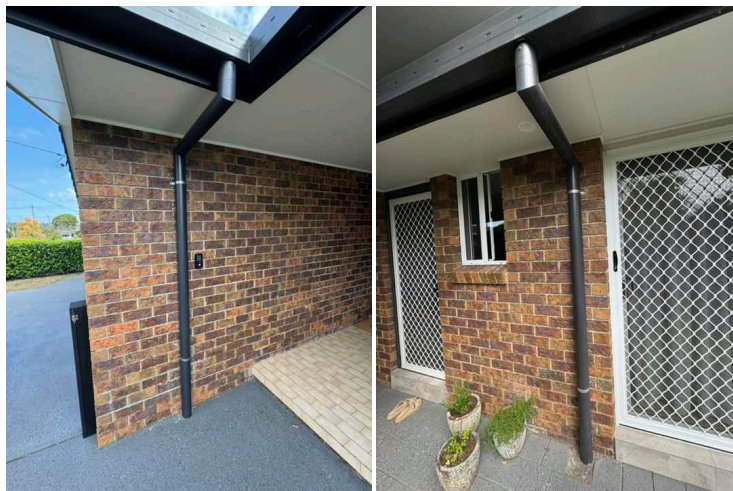

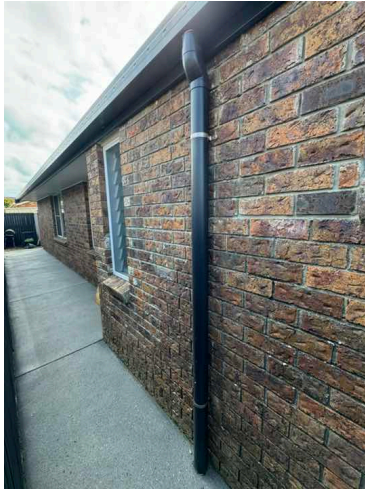



HOT WATER SYSTEM

Hot Water Unit

Hot Water Unit Findings

The hot water system appears to be in a serviceable condition. No specific tests other than running the hot water from a tap was carried out. No determination has been made as to the suitability or adequacy of the hot water system in relation to capacity or otherwise.

System Location

The hot water unit is located inside.

System Type

The hot water unit is an electric storage system.

System Make

Everhot



System Capacity

Hot water unit system capacity is 250 litre.

System Year of Manufacture

2023

Traditional storage tank water heaters have a life span of **around 10 years**. Tankless hot water systems such as instantaneous hot water systems can last up to 20 years.

External Plumbing Pipes

Plumbing Pipes

On visual inspection the external plumbing pipes appear serviceable, but should be checked by a qualified plumber.



EXTERIOR

Alfresco Area

Overall Condition

Visible sections of the Alfresco area are serviceable or in reasonable or condition for the age of this dwelling.



Eaves

Eave Condition

The soffit lining (eaves) are in a serviceable condition with no notable defects.

Eave lining damage visible. Recommendations: A qualified carpenter should be engaged for repairs.

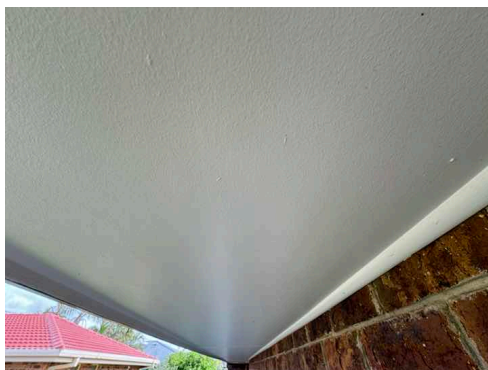
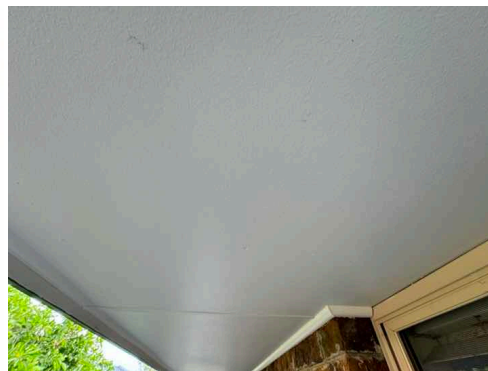
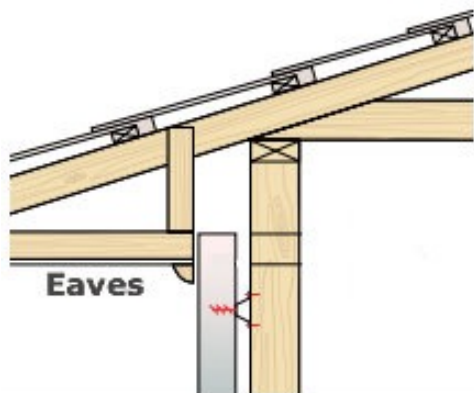

Entry Porch Area

Overall Condition

The entry porch serviceable or in reasonable or condition for the age of this dwelling.



External Door Components

Door Findings

On Visual Inspection the external condition of the doors is serviceable.

Fascia and Barge Boards

Condition

On visual inspection, the general condition of the fascia/barge boards is serviceable.

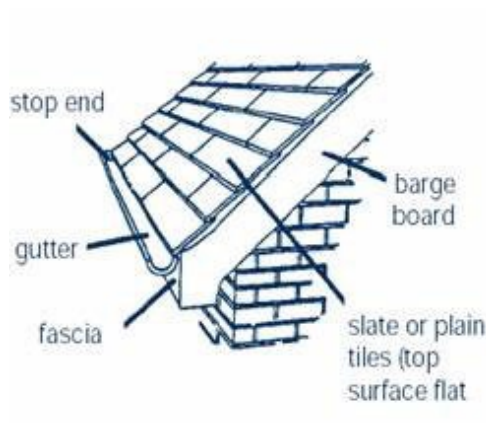



Rising Damp

Rising Damp Findings

Of the visible and accessible areas, there was no visible evidence of excessive rising damp on the external walls at time of inspection.

Damp Proof Course

A damp proof course (DPC) was noted.

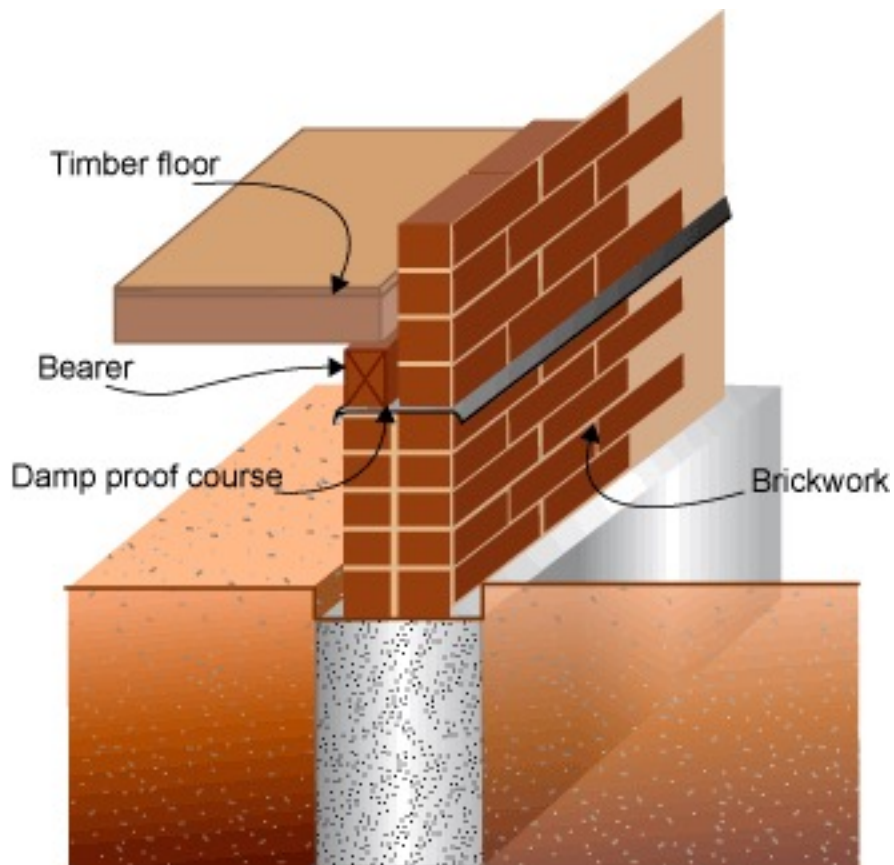

Walls

General Disclaimer

Refer to Section 2D of the Terms And Conditions section of this report.

Exterior Wall Material

Brick.

Condition

On visual inspection, the general condition of the exterior walls is serviceable for the age.

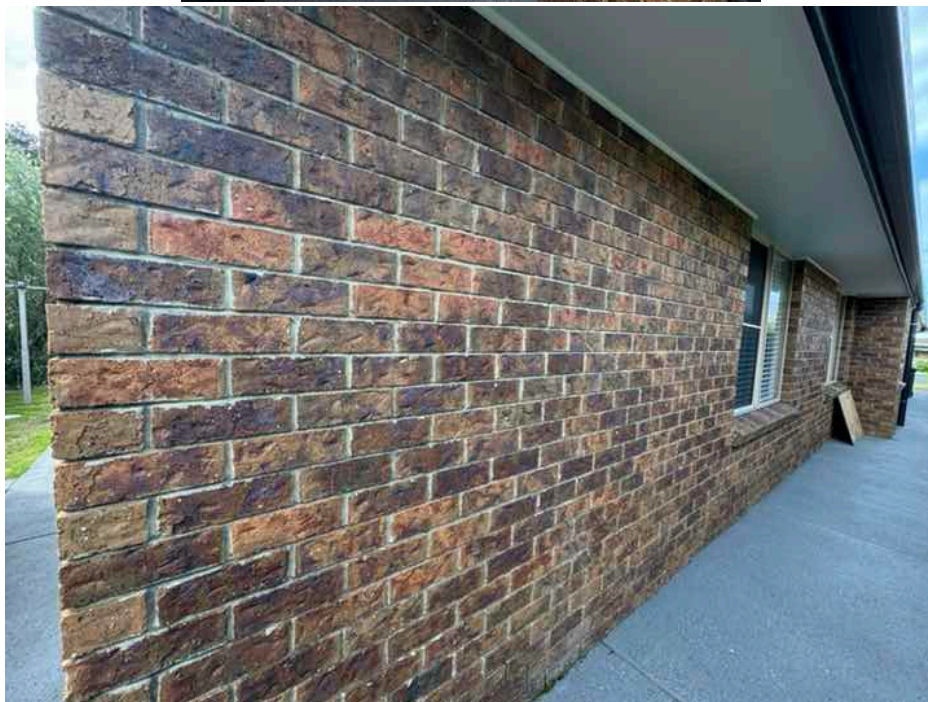
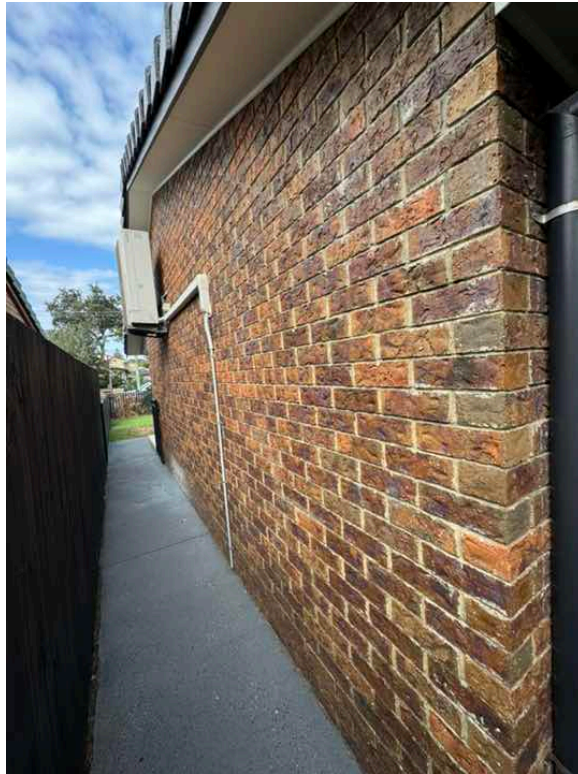

Windows

General Disclaimer

Please refer to section 2D of the Terms And Conditions Section of this report

Overall Condition

On visual inspection, the general condition of the windows is serviceable for the age.

Damaged fly screen/s replace as required.



Weep Holes and Ventilation

Findings

The weep holes are unobstructed .

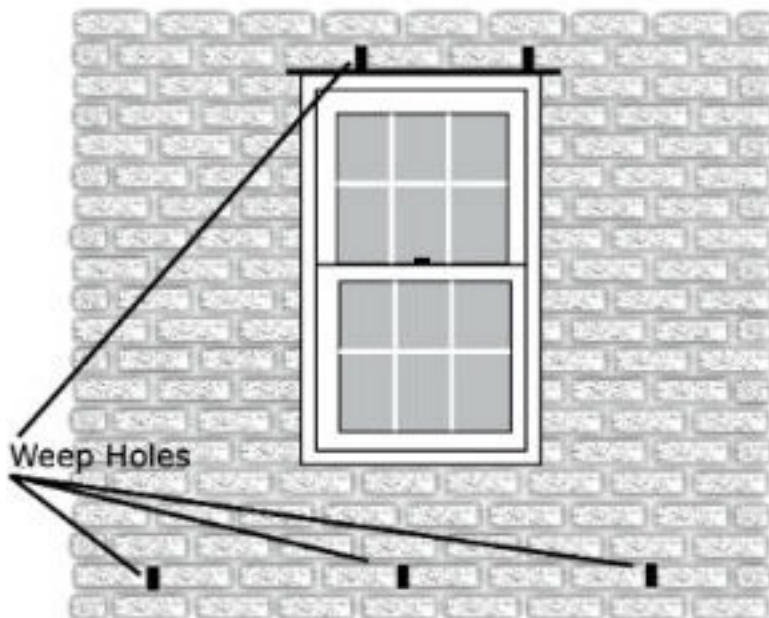

Weep holes allow air into the cavity and moisture to drain out



GARAGE - CARPORT

Garaging

Type

Attached garage.

Areas Restricted

Stored items restricted a full and thorough inspection of this area. Defects may exist in the obstructed and inaccessible areas. It is strongly recommended that full access be granted to enable a thorough inspection as there may be timber pest activity, damage or defects. Note: Where vehicles and storage has restricted a full inspection it is advised that this area be cleared so a full and unobstructed inspection can be carried out.

Overall Condition

From the visible and accessible areas, the garage appears to be in a serviceable condition for the age of the property with no notable structural defects sighted.

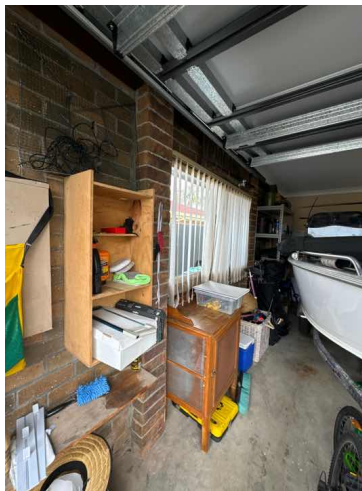

Roof And Gutter

Same as house. See house roof report.

Door Findings

Damp damage to door/frame - It appear water has damaged areas of the door. I am not able to ascertain if this is still occurring and this can only be ascertained during heavy rainfall periods. Contact a qualified carpenter for repairs.

Ceiling Findings

Butt joint separation noted to ceiling lining. Contact a licensed plasterer for repairs.

Settlement Cracks Noted . These are typical and generally patch and paint will suffice, however Monitoring these cracks advised for 12 months and if become wider or longer, you will need to contact a structural engineers to assess.

Cornice separation - I recommend you contact a qualified for repairs.

Ceiling stains - Moisture readings obtained - Possibly still active leaking. A qualified roofer/roofing plumber should be engaged for advice and recommendations. I strongly recommend that all water damaged plaster replaced by a qualified plasterer due to potential detachment or collapse.



STAIRS- PERGOLA- BALCONIES-DECKS

Pergola Findings

Overall Condition

The Pergola is in a serviceable condition with no notable defects sighted.



Balcony Findings

Overall Condition

Though we are not structural engineers the balcony/s appear to be in a serviceable condition.





Flooring

Tile cracking observed. A qualified tiler should be engaged for advice and recommendations. This may cause leaking and water penetration.

General Disclaimer

Please refer to section 2H of the Terms And Conditions section of this report.



INTERIORS

Doors

General Disclaimer

Please refer to section 2F of the Terms And Condition section of this report

Front Entry Doors

The doors are in serviceable condition with no notable defects observed.



Other Doors

Other doors such as sliding , side entry etc.. appear to be in serviceable condition.

Entry Foyer

Overall Condition

From the visible and accessible areas, this area appears to be in a serviceable condition for the age of the property with no notable structural defects sighted.

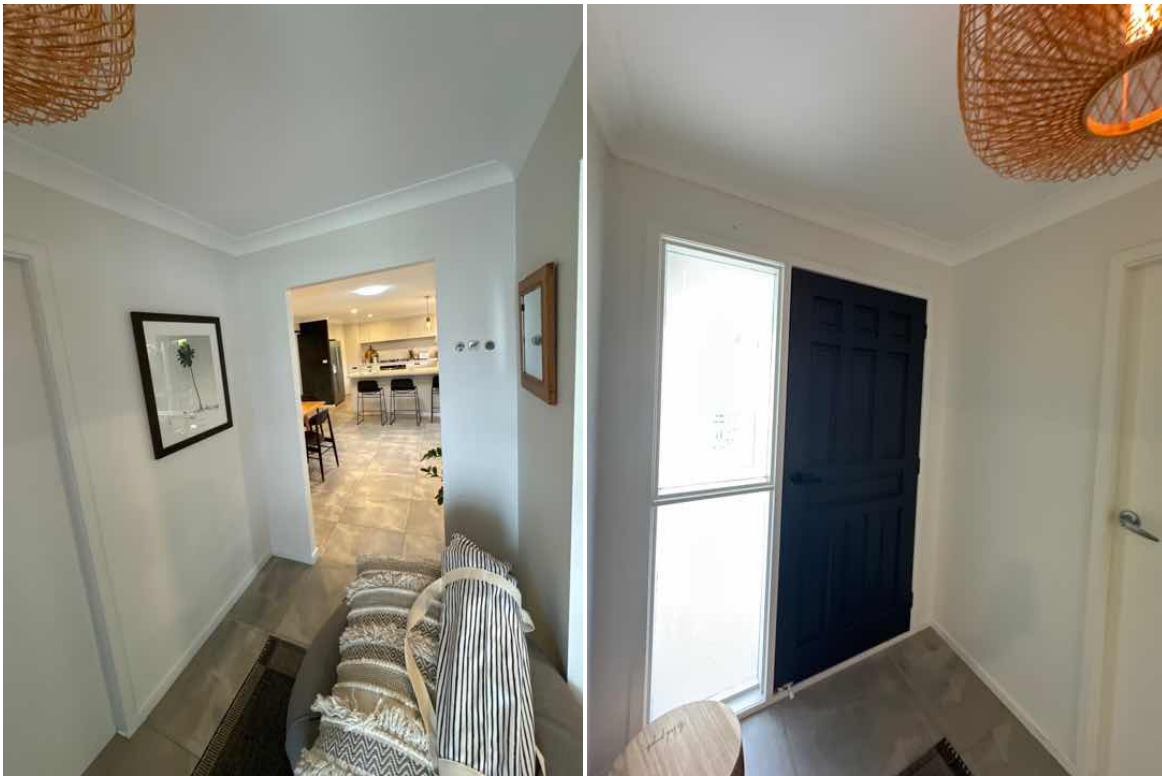

Living Room

Overall Condition

From the visible and accessible areas, this room appears to be in a serviceable condition for the age of the property with no notable structural defects sighted.





Dining Room

Overall Condition

From the visible and accessible areas, this room appears to be in a serviceable condition for the age of the property with no notable structural defects sighted.





Family Room

Overall Condition

From the visible and accessible areas, this room appears to be in a serviceable condition for the age of the property with no notable structural defects sighted.





Study

Overall Condition

From the visible and accessible areas, this room appears to be in a serviceable condition for the age of the property with no notable structural defects sighted.



Storage

Overall Condition

From the visible and accessible areas, this room appears to be in a serviceable condition for the age of the property with no notable structural defects sighted.



Flooring

Cracked floor tiles noted. A qualified tiler should be engaged for repairs.

Hallway/s

Overall Condition

From the visible and accessible areas, the hallway/ appears to be in a serviceable condition for the age of the property with no notable structural defects sighted.





Flooring

Drummy/loose tiles observed. Tile lift and further deterioration likely. Contact a qualified tiler for repairs.

Bedroom 1

Overall Condition

From the visible and accessible areas, this bedroom appears to be in a serviceable condition for the age of the property with no notable structural defects sighted.





Bedroom 2

Overall Condition

From the visible and accessible areas, this bedroom appears to be in a serviceable condition for the age of the property with no notable structural defects sighted.





Bedroom 3

Overall Condition

From the visible and accessible areas, this bedroom appears to be in a serviceable condition for the age of the property with no notable structural defects sighted.





Bedroom 4

Overall Condition

From the visible and accessible areas, this bedroom appears to be in a serviceable condition for the age of the property with no notable structural defects sighted.



Flooring

Stains observed - Steam cleaning may rectify stained areas but they appear entrenched.



BATHROOM(S)

Powder Room

Location

This bathroom is located in the hallway.

Overall Condition

Of the visible areas, the general condition of this bathroom is serviceable or in reasonable condition for age of dwelling.



Bathroom 1

Location

This bathroom is located in the master bedroom.

Overall Condition

Of the visible areas, the general condition of this bathroom is serviceable or in reasonable condition for age of dwelling.



Important Disclaimer

Refer to Section 7 of the Terms And conditions section of this report with regard to all Bathrooms.

Bathroom 2

Location

This bathroom is located in the hallway.

Overall Condition

Of the visible areas, the general condition of this bathroom is serviceable or in reasonable condition for age of dwelling.

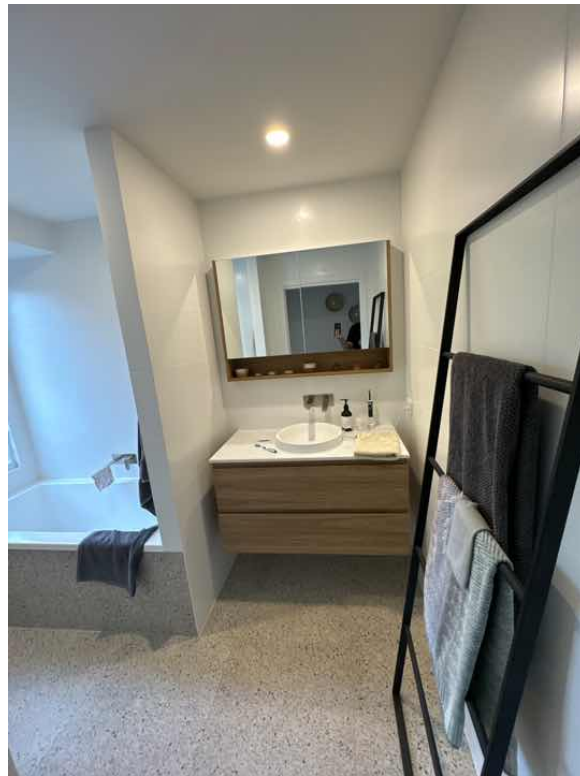



KITCHEN & LAUNDRY

Kitchen and Pantry

Overall Condition

Of the visible areas, the general condition of the kitchen and pantry is serviceable or in reasonable condition for age of dwelling.



Cupboards And Bench Tops

These components appear to be in a serviceable condition

Adjustment to cabinet doors required, in some instance hinges may need to be replaced.

Laundry

General Disclaimer

Laundry appliances are not tested or moved during the inspection and the condition of any walls or flooring hidden by them cannot be judged. Drain lines and water supply valves serving washing machines are not operated.

Restrictions

Appliances and the like restricted a full visual inspection.

Overall Condition

Of the visible areas, the general condition of the laundry is serviceable or in reasonable condition for age of dwelling.



Floor

Minor cracks floor tiles. A qualified tiler should be engaged for repairs.

Drummy tiles noted. This needs to be repaired at the earliest as this has the potential to lead to many related issues such as damp, water ingress to other areas and cracked tiles. Contact a qualified tiler for repairs and recommendation.



ROOF VOID

Roof Void Findings

General Disclaimer

Please refer to section 2B of the Terms And Conditions section of this report.

Restricted Areas

There is insulation present in the roof space/void. This is preventing a full inspection of ceiling joists from being undertaken. It is strongly recommended that full access be gained as it could be harbouring timber pest activity, damage or defects.

There is sarking present in the roof space/void. This is preventing a full inspection from being undertaken. It is strongly recommended that full access be gained as it could be harbouring timber pest activity, damage or defects.

Truss Webbing

Roof Frame Type

The roof frame is a truss timber frame.

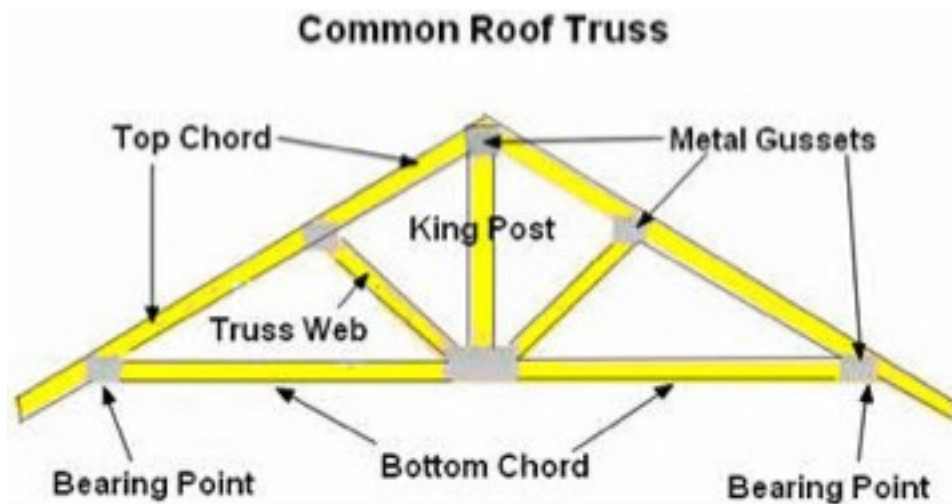

Overall Condition

Visible sections of the roof void is in a serviceable condition for age of this dwelling.

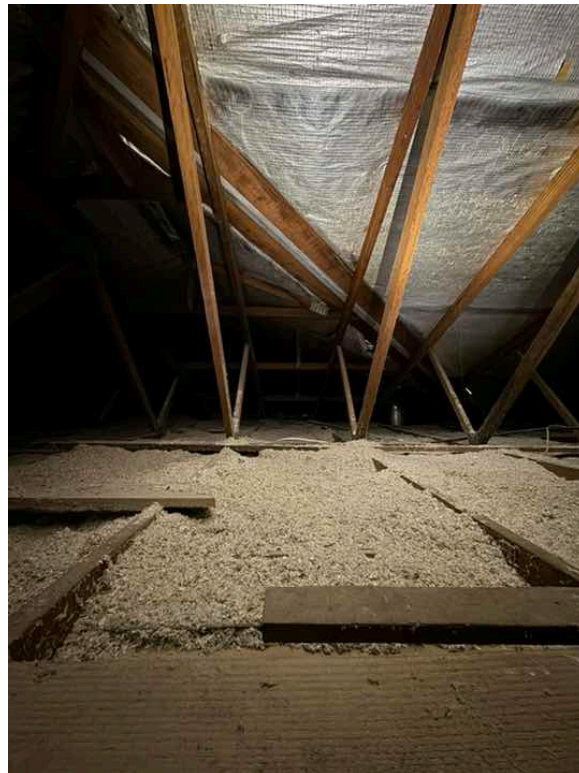

Insulation

Type

The roof space is insulated with loose fill insulation.

Condition

Where visible and accessible, the insulation appears to be in a serviceable condition.

Insufficient spacing between insulation and down lights. This poses a fire risk. Contact a qualified electrician for further advice and recommendations prior to a decision to purchase.

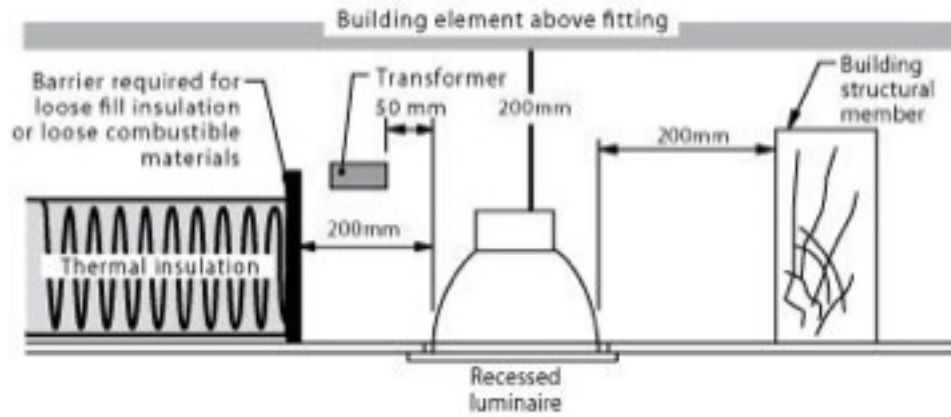

Sarking

Sarking is installed.

Sarking deteriorated/ damaged / aged in some sections. A qualified roofing contractor should be engaged for advice and recommendations.



CONCLUSION

Condition Of Inspected Structure

Overall Condition

The overall condition of this building has been compared to similar constructed buildings of approximately the same age where those buildings have had a maintenance program implemented to ensure that the building members are still fit for purpose.

The summary lists of Major and Minor defects included this report are the opinion of the inspector, other inspectors or individuals may have a different opinion to what is a Minor or a Major Defect

The incidence of major and minor defects and overall condition in this residential building as compared with similar buildings is listed below.

Please refer to the **TERMS AND CONDITIONS** section of this report for definition.

General Maintenance and Upkeep of This Property

The general maintenance and upkeep of this property is considered: **ABOVE AVERAGE**

The incidence of Major Defects

The incidence of major defects in this residential building as compared with similar buildings is considered **TYPICAL**

The Incidence of Minor Defects

The incidence of minor defects in this residential building as compared with similar buildings is considered **TYPICAL**

The Overall Condition Of This Dwelling

The overall condition of this residential dwelling in the context of its age, type and general expectations of similar properties is **ABOVE AVERAGE**





PROPERTY AND INSPECTION INFORMATION

Weather at Inspection Area

Weather Conditions

The weather was fine and dry at the time of the inspection.

The weather was overcast but dry at the time of the inspection.

There appeared to have been rainfall in the preceding 24 hours.

Property Information

Direction House Faces

The dwelling faces East for the purposes of this inspection report.

Building Type

The structure is a residential house.

Construction Type

The structure is of brick veneer construction.

BRICK VENEER WALL

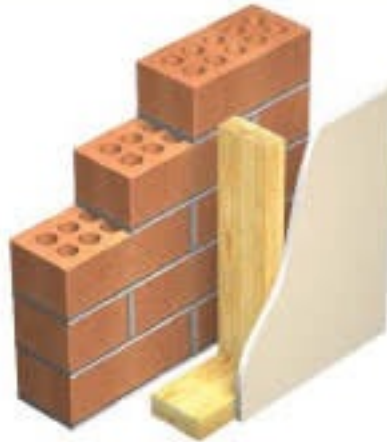

Roof Cladding

Tile roofing.

Roof Design

The roof is a pitched roof design.

Footings Type

Slab on ground construction.

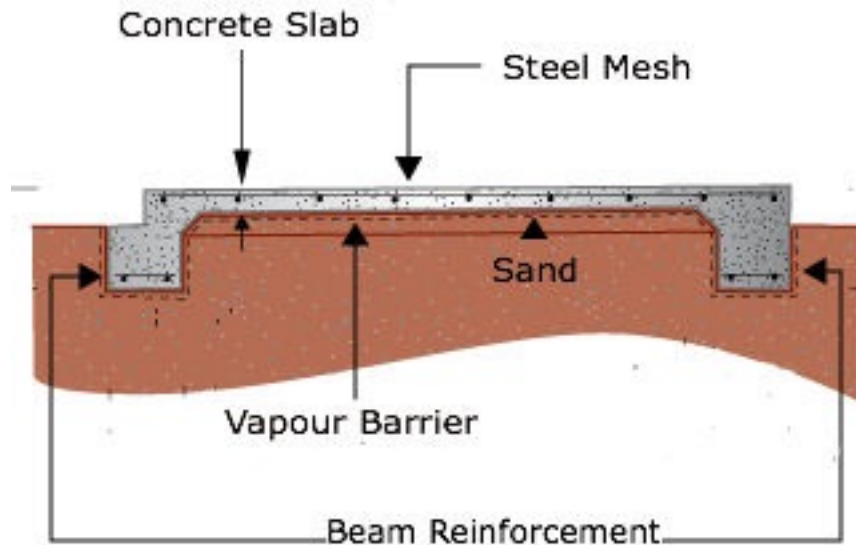

Storeys

Single level dwelling.

Property Occupied

The property was occupied.

Property Furnished

The property was fully furnished.

People Present

The estate agent was present.

Access and Restrictions

Inspected Areas

Building exterior.

Building interior.

The garage.

The Roof void.

The site.

Area Where Inspection Was Restricted

Furniture and belongings restricted full visual inspection of the building interior.

Clearances, ducting and insulation where applicable restricted full visual inspection of the roof void.

Areas Not Inspected

Inaccessible roof void sections due to access limitations and or insulation and ducting.

Utility Status

Water

The water was Connected. All plumbing pipe installation should be assessed by a licensed plumber.

Electricity

Electricity to the dwelling was connected. Note: We do not carry out electrical inspections for wiring or safety. This must be carried out by a licensed electrician and I recommend you have all electrical wiring and components assessed by a licensed electrician.

Apparent Concealment of possible defects

Were apparent Concealments seen

No apparent concealing of defects was visible.

inspection Agreement

Were there any specific requirements to The Pre Inspection Agreement

No specific requirements to the inspection or Pre inspection agreement were requested by the client or their legal representatives.



TERMS AND CONDITIONS

The purpose of the inspection is to identify the major defects and safety hazards associated with the property at the time of the inspection. The inspection and reporting is limited to a visual assessment of structure in accord with AS 4349.1 appendix "C" or if not a pre-purchase report then the report complies with AS4349.0. This is a general appraisal only and cannot be relied on its own, a further inspection by specialist and qualified trades is strongly recommended.

NOT A PEST REPORT: This inspection and report will not inspect, seek or attempt to identify timber pest activity or damage. We strongly recommend you obtain a timber pest inspection conducted by a licensed and suitably qualified pest inspector.

DEFINITIONS AND TERMINOLOGY

SERVICEABLE: The building material or component is in reasonable or serviceable condition for the age of the dwelling.

TRADESMAN: A defect or a number of defects were visible that will require assessment by a qualified trades person.

AGE: The component has deterioration due to ageing or lack of upkeep and or maintenance.

MONITOR: Some defects may require monitoring to ascertain if the defect will worsen, reappear or cause further problems.

STRATA: In the case of strata and company title properties, the inspection is limited to the interior and immediate exterior of the particular unit being inspected report.

HIGH: The frequency and/or magnitude of defects are beyond the inspector's expectations when compared to similar buildings of approximately the same age that have been reasonably well maintained.

TYPICAL: The frequency and/or magnitude of defects are consistent with the inspector's expectations when compared to similar buildings of approximately the same age which have been reasonably well maintained.

LOW: The frequency and/or magnitude of defects are lower than the inspector's expectations when compared to similar buildings of approximately the same age that have been reasonably well maintained.

ABOVE AVERAGE: The overall condition is above that consistent with dwellings of approximately the same age and construction. Most items and areas are well maintained and show a reasonable standard of workmanship when compared with buildings of similar age and construction.

AVERAGE: The overall condition is consistent with dwellings of approximately the same age and construction. There will be areas or items requiring some repair or maintenance.

BELOW AVERAGE: The building and its parts show some significant defects and/or very poor non-tradesman like workmanship and/or long-term neglect and/or defects requiring major repairs or reconstruction of major building.

SIGNIFICANT ITEMS: An item that must be reported in accordance with the scope of the inspection.

MAJOR DEFECT: A defect of sufficient magnitude requiring building works to avoid unsafe conditions, loss of function or further worsening of the defective item.

MINOR DEFECT: Any defect other than what is described as a Significant Item or major defect.

SAFETY HAZARD: A defect that presents unsafe conditions and must be reported as a Major defect.

ACCESSIBLE AREA: Is any area of the property and structures allowing the inspector safe and reasonable access within the scope of the inspection.

LIMITATION: A factor that prevents full or proper inspection of the building.

IMPORTANT INFORMATION

Important information regarding the scope and limitations of the inspection and this report. Any person who relies upon the contents of this report does so acknowledging that the following clauses, which define the scope and limitations of the inspection, form an integral part of the report. The inspection comprised a visual assessment of the property to identify major defects and to form an opinion regarding the general condition of the property at the time and date of the visual inspection. An estimate of the cost of rectification of defects is outside the scope of Australian Standard AS 4349 and does not form part of this report. If the property inspected is part of a Strata or Company Title, then the inspection is limited to the interior and the immediate exterior of that particular residential dwelling. The inspection does not cover common property. This report and any other attached report should not be relied upon if the contract for sale becomes binding more than 30 days after the date of initial inspection. A re-inspection after this time is essential. Further, this report is not intended to be used as a marketing tool by and real-estate agents and only the person named in the **CLIENT INFORMATION** section of the report shall this report apply to as it is assumed and agreed that the person who orders the report is indeed the person purchasing the property inspected. Where a report is ordered on behalf of a **CLIENT** it is assumed that the terms and condition and Pre Inspection Agreement have been fully explained to the **CLIENT** by the person or company ordering the report.

We strongly advise that any cracking reported in this report should be referred to a structural engineer for further assessment and advice. Please refer to Cracking Of Building Elements in section 2G of these Terms And Condition

Acceptance Criteria: The building shall be compared with a building that was constructed in accordance with the generally accepted practice at the time of construction and which has been maintained such that there has been no significant loss of strength and serviceability.

Limitations: This report is limited to a visual inspection of areas where safe and reasonable access is available and access permitted on the date and at the time of inspection. The Inspection will be carried out in accordance with AS4349.1-2007. The purpose of the inspection is to provide advice to a prospective purchaser regarding the condition of the property at the date and time of inspection. Areas for Inspection shall cover all safe and accessible areas. It does not purport to be geological as to foundation integrity or soil conditions, engineering as to structural, nor does it cover the condition of electrical, plumbing, gas or motorised appliances. It is strongly recommended that an appropriately qualified contractor check these services prior to purchase. As a matter of course, and in the interests of safety, all prospective purchasers should have an electrical report carried out by a suitably qualified contractor. This report is limited to (unless otherwise noted) the main structure on the site and any other building, structure or outbuilding within 30m of the main structure and within the site boundaries including fences.

Safe and Reasonable Access: Only areas to which safe and reasonable access is available were inspected. The Australian Standard AS4349.1 or AS4349.0 defines reasonable access as "areas where safe, unobstructed access " is provided and the minimum clearances specified below are available, or where these clearances are not available, areas within the inspector's unobstructed line of sight and within arm's length. Reasonable access does not include removing screws and bolts to access covers. Reasonable access does not include the use of destructive or invasive inspection methods and does not include cutting or making access traps or moving heavy furniture, floor coverings or stored goods.

Roof Interior- Access opening 400 x 500 mm - Crawl Space 600 x 600mm - Height accessible from a 3.6m ladder.

Roof Exterior- Must be accessible from a 3.6m ladder placed on the ground.

1) NOT A CERTIFICATE OF COMPLIANCE: This report is not an all-encompassing report dealing with the building from every aspect. It is a reasonable attempt to identify any obvious or significant defects apparent at the time of the inspection. Whether or not, a defect is considered significant or not depends too a large extent, upon the age and type of the building inspected. This report is not a certificate of compliance with the requirements of any act, regulation, ordinance or by-law. It is not a structural report. Should you require any advice of a structural nature you should contact a structural engineer.

2) VISUAL INSPECTION: This is a visual inspection only limited to those areas and sections of the property safe that are fully accessible safe to access and visible to the inspector on the date of inspection.

2A) Please refer to each individual area regarding sections that were incapable or being inspected. Please acknowledge the following. Where a complete inspection of some areas listed through the report may not have been physically possible (due to but not limited to storage, furniture, beds, personal belongings in cupboards and/or wardrobes, the 2nd storey roofing, gutters, fascia, flashings and the like, low clearance in sub-floor or roof void areas, ducts and deep insulation restricting access in roof voids, sub-floor restrictions including plumbing, ducts, low clearance, no access doors or access doors too small and the like) then it follows that defects, timber pest activity and/or damage may exist in these areas. To adequately inspect these restricted areas, ducts and floor boards may need to be removed, furniture moved, cupboards and wardrobes emptied which will be difficult to carry out. This will obviously be difficult to carry out due to time restrictions and permission would need to be obtained from the property owner.

This Firm **DOES NOT GUARANTEE IN ANY WAY** that there **ARE OR ARE NOT** any defects, termite damage or live termites in any areas not inspected. To obtain a full understanding of the report findings, it is essential you read the entire inspection report, including the information sections at the end of this report and I encourage you to call me if you have any queries at all before purchasing.

2B) Entering attics or roof voids that are insulated can cause damage to the insulation and attic framing. Attics with deep insulation cannot be safely inspected due to limited visibility of the framing members upon which the inspector must walk. In such cases, the attic is only partially accessed, thereby limiting the review of the attic area from the hatch area only. Inspectors will not crawl the attic area when they believe it is a danger to them or that they might damage the attic insulation or framing. There is a limited review of the attic area viewed from the hatch only in these circumstances.

2C) The roof covering will not be walked upon if in the opinion of the inspector it is not safe to do so. Generally issues that prevent roof access include, access height over 3 metres, steep pitch, wet/slippery surfaces, deteriorated covering. Not being able to walk a roof significantly limits our inspection, which can result in hidden defects going undetected. The overall condition of the roofing and its components is an opinion of the general quality and condition of the roofing material. The inspector cannot and does not offer an opinion or warranty as to whether the roof leaks or may be subject to future leakage. This report is issued in consideration of the foregoing disclaimer. The only way to determine whether a roof is absolutely watertight is to observe it during a prolonged rainfall. Many times, this situation is not present during the inspection. We offer no guarantee that the roof cladding or roof components such as flashing will not leak in the future.

2D) Limitations to the exterior inspection this is a visual inspection limited in scope by (but not restricted to) the following conditions: A representative sample of exterior components was inspected rather than every occurrence of components. The inspection does not include an assessment of geological, geotechnical, or hydrological conditions, or environmental hazards. Screening, shutters, awnings, or similar seasonal accessories, fences, recreational facilities, outbuildings, seawalls, break-walls, docks, erosion control and earth stabilization measures are not inspected unless specifically agreed-upon and documented in this report. Please note. If any wall cracking/cracks/openings are found at this dwelling, we cannot offer any guarantee that any visible wall cracks will not widen or lengthen over time or in the future as this is impossible to predict. We strongly recommend you contact a practicing structural engineer for further advice.

2E) Timber framed windows can bind or stick. This can be seasonal due to the fluctuation in moisture content in timber. If binding or sticking continues a carpenter may require adjustments. Binding windows is not normally a major defect, however in some circumstances binding windows and doors can be directly related to some differential footings settlement. If any timber fungal decay on frames or deteriorated putty seals is noted, the consultant will not attempt to operate windows due to potential damage. Windows that are sticking, binding or paint stuck will also not be forced open. Water leaks to windows and surrounds cannot be determined in the absence of rain.

2F) Internal Inspections. Carpets and or other floor coverings, cupboards/cabinets, joinery, finishes and fittings, normally obstruct inspection to the upper-side of flooring. Defects or timber pest damage may be present and not detected in areas where inspection was limited, obstructed or access was not gained. The condition of walls behind wall coverings, panelling and furnishings cannot be inspected or reported on. Only the general condition of visible areas is included in this inspection. Where fitted. Wood burning and other forms of fireboxes are outside the scope of this inspection. We recommend you have these tested prior to purchase for peace of mind.

2G) Cracking of Building Elements: Regardless of the type of crack(s) the inspector carrying out a visual inspection is unable to determine the expected consequences of the cracks. As a crack on the day can be 1mm wide but may have the potential to develop over time into structural problems for the home owner resulting in major expensive rectification work.

Information required to determine the consequences of a crack:

Nature of the foundation material on which the building is resting

- a) The design of the footings
- b) The site landscape and topography
- c) The history of the cracks

All these factors fall outside the scope of this inspection. However the information obtained from the items above are valuable in determining the expected consequences of the cracking and any remedial work.

Cracking Categories:

Cracking is also categorized into the following 5 categories with a description of typical damage and required repairs:

0-Hairline cracking, less than 0.1mm,

1-Fine cracks that do not need repair, less than 1.0mm,

2-Noticeable cracks, yet easily filled 1mm - 5.0mm,

3-Cracks that can be repaired and possibly some of the wall sections will need to be replaced. Weather tightness can be impaired, 5.0mm -15.0mm,

4-Extensive repair works required involving breaking out and replacing these sections. Walls can become out of plumb and fall and causes reduced bearing capacity, 15.0mm - 25.0mm.

IMPORTANT: Regardless of location or size If cracks have been identified then a structural engineer is required to determine the significance of the cracking prior to a decision to purchase.

2H) Important Note: Where any elevated structure (deck, balcony, veranda etc.) is present, and this elevated structure is designed to accommodate people, you must have this structure checked by an engineer or other suitably qualified person. You should also arrange annual inspections of the structure by an engineer or other suitably qualified person to ensure any maintenance that may become necessary is identified. Care must be taken not to overload the structure. Nothing contained in this inspection should be taken as an indicator that we have assessed any elevated structure as suitable for any specific number of people or purpose. A qualified engineer can only do this. For the purpose of this report, the structure includes elevated decks; verandas, pergolas, balconies, handrails, stairs and children's play areas. Where any structural component is concealed by lining materials or other obstructions, these linings or obstructions must be removed to enable an evaluation to be carried out by an appropriately qualified person.

3) CONCEALED DEFECTS: This report does not and cannot make comment upon: Defects that may have been concealed the assessment or detection of defects (including rising damp and leaks) which may be subject to the prevailing weather conditions whether or not services have been used for some time prior to the inspection and whether this will affect the detection of leaks or other defects e.g. In the case of shower enclosures and bath tubs, the absence of any leaks or dampness at the time of the inspection does not necessarily mean that the enclosure will not leak after use) the presence or absence of timber pests; gas-fittings; common property areas; environmental concerns; the proximity of the property to flight paths, railways, or busy traffic; noise levels; health and safety issues; heritage concerns; security concerns; fire protection; site drainage (apart from surface water drainage); swimming pools and spas (non-structural); detection and identification of illegal building work; detection and identification of illegal plumbing work; durability of exposed finishes; neighbourhood problems; document analysis; electrical installation; any matters that are solely regulated by statute; any area(s) or item(s) that could not be inspected by the consultant.

4) NO GUARANTEE: Accordingly this report is not a guarantee that defects and/or damage do not exist in any inaccessible or partly inaccessible areas or sections of the property. Such matters may upon request be covered under the terms of a special purpose property report.

5) SWIMMING POOLS: Swimming pools/spas are not part of the standard building report under as4349.1-2007 and are not covered by this report. We strongly recommend a pool expert should be consulted to examine the pool and the pool equipment and plumbing as well as the requirements to meet the standard for pool fencing. Failure to conduct this inspection and put into place the necessary recommendations could result in finds for non-compliance under the legislation.

6) SURFACE WATER AND DRAINAGE: The retention of water from surface run off could have an effect on the foundation material which in turn could affect the footings to the house. Have water directed away from the house or to storm water pipes by a licensed drainage plumber. The general adequacy of site drainage is not included in the standard property inspection report. Comments on surface water drainage are limited as where there has been either little or no rainfall for a period of time; surface water drainage may appear to be adequate but then during periods of heavy rain, may be found to be inadequate. Any comments made in this report are relevant only to the conditions present at the time of inspection. It is recommended that a smoke test be obtained to determine any illegal connections, blocked or broken drains.

7) SHOWER RECESSES: All Shower areas are visually checked for leakage, but leaks often do not show except when the shower is in actual long-term use. Determining whether shower areas, bath/shower surrounds are watertight is beyond the scope of this inspection. It is very important to maintain adequate sealing in the bath areas. Very minor imperfections can allow water to get into the wall or floor areas and cause damage. Adequate and proper ongoing maintenance will be required in the future. Tests may be made on shower recesses to detect leaks (if water is connected). The tests may not reveal leaks or show incorrect waterproofing if silicone liquid or masonry sealant has been applied prior to the inspection. Such application is a temporary waterproofing measure and may last for some months before breaking down. The tests on the shower recesses are limited to running water within the recesses and visually checking for leaks as showers are only checked for a short period of time, prolonged use may reveal leaks that were not detected at the time of inspection. No evidence of a current leak during inspection does not necessarily mean that the shower does not leak.

8) GLASS CAUTION: Glazing in older houses (built before 1978) may not necessarily comply with current glass safety standards AS1288. In the interests of safety, glass panes in doors and windows especially in traffic-able areas should be replaced with safety glass or have shatterproof film installed unless they already comply with the current standard.

9) STAIRS AND BALUSTRADES: Specifications have been laid down by the National Construction Code Section 3.9 covering stairs, landings, balustrades to ensure the safety of all occupants and visitors in a building. Many balustrades and stairs built before 1996 may not comply with the current standard. You must upgrade all such items to the current standard to improve safety.

10) RETAINING WALLS: Where retaining walls are more than 700mm high these wall/s should have been installed with engineering design and supervision. Walls found on the site were not assessed and the performance of these walls is not the subject of a standard property report and should be further investigated with regard to the following items, adequate drainage systems, adequate load bearing, correct component sizing and batter.

11) ROOMS BELOW GROUND LEVEL: If there are any rooms under the house or below ground level (whether they be habitable or non-habitable rooms), these may be subject to dampness and water penetration. Drains are not always installed correctly or could be blocked. It is common to have damp problems and water entry into these types of rooms, especially during periods of heavy rainfall and this may not be evident upon initial inspection. These rooms may not have council approval. The purchaser should make his or her own enquiries with the Council to ascertain if approval was given.

12) ASBESTOS DISCLAIMER: No inspection for asbestos was carried out at the property and no report on the presence or absence of asbestos is provided.

13) MOULD (mildew and non-wood decay fungi) disclaimer: Mildew and non-wood decay fungi is commonly known as mould. However, mould and their spores may cause health problems or allergic reactions such as asthma and dermatitis in some people. No inspection for mould was carried out at the property and no report on the presence or absence of mould is provided.

14) MAGNESITE DISCLAIMER: No inspection for Magnesite flooring was carried out at the property and no report on the presence or absence of Magnesite flooring is provided. You should ask the owner whether Magnesite flooring is present and/or seek advice from a structural engineer.

15) ESTIMATING DISCLAIMER: No estimate is provided in this report. We strongly recommend you obtain quotes for repairs from licensed tradesman prior to a decision to purchase.

16) DISCLAIMER OF LIABILITY: No liability shall be accepted on an account of failure of the report to notify any problems in the area(s) or section(s) of the subject property physically inaccessible for inspection, or to which access for inspection is denied by or to the inspector (including but not limited to or any area(s) or section(s) so specified by the report) Compensation will only be payable for losses arising in contract or tort sustained by the client named on the front of this report. Compensation is limited to the price of the report initially paid by the claimant named in the report as the "CLIENT"

17) DISCLAIMER OF LIABILITY TO THIRD PARTIES: Compensation will only be payable for losses arising in contract or tort sustained by the Client named on the front of this report. Any third party acting or relying on this Report, in whole or in part, does so entirely at his or her own risk.

18) COMPLAINTS PROCEDURE: In the event of any dispute or claim arising out of, or relating to the Inspection or the Report, You must notify Us as soon as possible of the dispute or claim by email, fax or mail. You must allow Us (which includes persons nominated by Us) to visit the property (which visit must occur within twenty eight (28) days of your notification to Us) and give Us full access in order that We may fully investigate the complaint. You will be provided with a written response to your dispute or claim within twenty eight (28) days of the date of the inspection.

If You are not satisfied with our response You must within twenty one (21) days of Your receipt of Our written response refer the matter to a Mediator nominated by Us from the Institute of Arbitrators and Mediators of Australia. The cost of the Mediator will be borne equally by both parties or as agreed as part of the mediated settlement.

In the event You do not comply with the above Complaints Procedure and commence litigation against Us then You agree to fully indemnify Us against any awards, costs, legal fees and expenses incurred by Us in having your litigation set aside or adjourned to permit the foregoing Complaints Procedure to complete.

OTHER RECOMMENDED INSPECTIONS

Electrical installation: All electrical wiring, meter-box and appliances need to be checked by a qualified electrician. The inspection of any electrical item is outside the scope of this report.

Plumbing: All plumbing including septic tanks need to be inspected and reported on by a plumber.

Hot water service: Hot water services need to be checked by a plumber and/or electrician.

Gas: All gas services need to be inspected and reported on by a gas plumber.

Phone: All phones, phone lines and outlets need to be inspected and reported on by a telecommunications technician.

Smoke Alarm: Australian standard AS3786 advises that smoke alarms are required for all buildings where people sleep. It is recommended that an electrician be consulted to give advice on those installed or to install smoke alarms.

Trees: Where trees are too close to the house this could affect the performance of the footing as the moisture levels change in the ground.

Contact the inspector: Please feel free to contact the inspector who carried out this inspection. Often it is very difficult to fully explain situations, problems, access difficulties, building faults or their importance in a manner that is readily understandable by the reader. Should you have any difficulty in understanding anything contained within this report then you should immediately contact the inspector and have the matter explained to you. If you have any questions at all or require any clarification then contact the inspector prior to acting on this report.



TIMBER PEST INSPECTION

Please note that this inspection and report was a Visual only inspection to the readily accessible areas of the property as defined within the terms and conditions of this report.

Please ensure that you read all sections of the report as well as the additional information at the rear of Please note that this inspection and report was a Visual only inspection to the readily accessible areas of the property as defined within the terms and conditions of this report. As this is a visual inspection only there may be damage to structural timbers within the building from termite infestation that is concealed by wall/s and or ceiling linings, and that such damage has neither been inspected for nor reported herein. Please ensure that you read all sections of the report as well as the additional information at the rear of the report and understand the limitations and the special recommendations for this construction style. If there is something you do not understand or require further clarification. Please contact the Inspector. **IMPORTANT: The Client acknowledges that, unless stated otherwise, the Client, as a matter of urgency should implement any recommendation or advice given in this report. Please contact the inspector If there is something you do not understand or require further clarification on.**



ACCESS AND RESTRICTIONS

Note

Inspection Information

For the purpose of visual timber pest inspection this timber pest inspection report which form part of a combined timber pest and building inspection. The inspection information listed at the beginning of the building inspection report namely report information shall apply. Including the date and time of inspection, agreement number, who the report is prepared for and the description of the property inspected. **THIS IS A VISUAL INSPECTION ONLY** in accord with the requirements of AS4349.3-2010 - Inspection of buildings Part 3: Timber Pest Inspections.

Summary Only

Important Disclaimer

Important disclaimer: This summary and the opinion are supplied to allow a quick and superficial overview of the inspection results. This summary is not the report and cannot be relied upon on its own. This summary must be read in conjunction with the full report and not in isolation from the report. If there should happen to be any discrepancy between anything in the report and anything in this summary, the information in the report shall override that in this summary. The report is subject to terms and limitations. Note: It is essential that you read the entire report; other inspectors may have and are entitled to different opinions in relation to this dwelling. Note: This report should not be relied upon if the contract for sale becomes binding more than 30 days after the date of initial inspection. A re-inspection after this time is essential.

1.1 Access to Areas

Areas where Access Should be Gained

No. Please read the report in its entirety.

1.2 Timber Pest Activity

Was there any Termite Workings or Damage Found

No: Of the areas able to be inspected there were no termite workings or termite damage visible. Please read this report in its entirety.

Were Any Live or Active Termites Found

No: Please read this report in its entirety

NOTE

Note: Any evidence of termite activity or workings in the grounds or building structure assumes that the risk to buildings is extremely high. We strongly recommend a treatment to eradicate the termites and to protect the building.

Any Visible Borer of seasoned Timbers Found

No: Please read this report in its entirety.

Any Damage caused by Wood Decay, Rot Found

No: Please read this report in its entirety.

Evidence Of Chemical Delignification

No: Please read this report in its entirety.

NOTE

For complete and accurate information please refer to the attached complete visual timber pest report, provided in accord with as 4349.3-2010

Are further inspections recommended

No: Please read this report in its entirety.

Where any major safety hazards identified

No: Please read this report in its entirety.

Susceptibility of this property to timber pests

In our opinion, the susceptibility of this property to timber pests is considered to HIGH. Read the report in full.

Is a Invasive Inspection Recommended

No: Please read this report in its entirety.

1.3 Brief Description of the Structure Inspected**Building Type**

Please refer to the description of the property outlined in the Building Inspection section of this report.

Terms and Limitations**Important Information**

Any person who relies upon the contents of this report does so acknowledging that the following clauses, which define the scope and limitations of the inspection, form an integral part of the report.

1. This is a visual inspection only in accord with the requirements of as 4349.3 Inspection of buildings part 3: Timber pest inspections. This visual inspection was limited to those areas and sections of the property to which reasonable access (see definition) was both available and permitted on the date of inspection. The inspection did not include breaking apart, dismantling, removing or moving objects including, but not limited to, foliage, mouldings, roof insulation/sisalation, floor or wall coverings, sidings, ceilings, floors, furnishings, appliances or personal possessions. The inspector cannot see inside walls, between floors, inside skillion roofing, inside the eaves, behind stored goods in cupboards, in other areas that are concealed or obstructed. The inspector did not dig, gouge, force or perform any other invasive procedures. An invasive inspection will not be performed unless a separate contract is entered into. In an occupied property it must be understood that furnishings or household items may be concealing evidence of timber pests, which may only be revealed when the items are moved or removed. In the case of strata type properties only the interior of the unit is inspected.

2. Scope of report: This report is confined to reporting on the discovery, or non-discovery, of infestation and/or damage caused by subterranean and dampwood termites (white ants), borers of seasoned timber and wood decay fungi (hereinafter referred to as 'timber pests'), present on the date of the inspection. The inspection did not cover any other pests and this report does not comment on them. Dry wood termites (family: Kalotermitidae) and European house borer (hylotrupes bujulus Linnaeus) were excluded from the inspection, but have been reported on if, in the course of the inspection, any visual evidence of infestation happened to be found. If cryptotermes brevis (West Indian dry wood termite) or hylotrupes bujulus Linnaeus are discovered we are required by law to notify government authorities. If reported a special purpose report may be necessary.

3. Hidden damage: If timber pest activity and/or damage is found, within the structures or the grounds of the property, then damage may exist in concealed areas, e.g. framing timbers. An invasive inspection is strongly recommended in this case. Damage may only be found when wall linings, cladding or insulation are removed to reveal previously concealed timbers.

4. Accesibility: A further inspection is strongly recommended of those areas that were not readily accessible and of inaccessible or obstructed areas once access has been provided or the obstruction removed. At the request of the named client on this report and with the written consent of the vendor, we will revisit the site and re-Inspect the obstructed Areas at no cost to you.

5. Limitations: Nothing contained in the report implies that any inaccessible or partly inaccessible areas or sections of the property being inspected by the inspector on the date of the inspection were not, or have not been, infested by timber pests. Accordingly this report is not a guarantee that an infestation and/or damage does not exist in any inaccessible or partly inaccessible areas or sections of the property. Nor is it a guarantee that a future infestation of timber pests will not occur or be found.

6. Determining extent of damage: The report is not a structural damage report. Any observations or recommendations about timber damage should not be taken as expert opinion and cannot be relied upon. The report will not state the full extent of any timber pest damage. The report will state timber damage found as slight, moderate, moderate to extensive or extensive. This information is not the opinion of an expert. If any evidence of timber pest activity and/or damage resulting from timber pest activity is reported either in the structure(s) or the grounds of the property, then you must assume that there may be concealed structural damage within the building(s). This concealed damage may only be found when wall linings, cladding or insulation is removed to reveal previously concealed timbers. An invasive timber pest inspection (for which a separate contract is required) is strongly recommended and you should arrange for a separate inspection by a qualified builder, engineer, or architect to carry out a structural inspection and to determine the full extent of the damage and the extent of repairs that may be required. You agree that either we or the individual conducting the inspection is responsible or liable for the repair of any damage whether disclosed by the report or not.

7. Mould: Mildew and non-wood decay fungi is commonly known as mould and is not considered a timber pest. However, mould and their spores may cause health problems or allergic reactions such as asthma and dermatitis in some people. No inspection for mould was carried out at the property and no report on the presence or absence of mould is provided. Should any evidence of mould happen to be noticed during the inspection, it will be noted in the other information (5.11) Section of this report. If mould is noted as present within the property and you are concerned as to the possible health risk resulting from its presence then you should seek advice from your local council, state or commonwealth government health department or a qualified expert such as an industry hygienist.

8. Disclaimer of liability: No liability shall be accepted on account of failure of the report to notify any termite activity and/or damage present at or prior to the date of the report in any areas(s) or section(s) of the subject property physically inaccessible for inspection, or to which access for inspection is denied by or to the licensed inspector (including but not limited to any area(s) or section(s) so specified by the report).

9. Disclaimer of liability to third parties: Compensation will only be payable for losses arising in contract or tort sustained by the client named on the front of this report. Any third party acting or relying on this report, in whole or in part, do so entirely at his or her own risk.

10. Complaints procedure: In the event of any dispute or claim arising out of, or relating to the inspection or the report, you must notify us as soon as possible of the dispute or claim by email, fax or mail. You must allow us (which includes persons nominated by us) to visit the property (which visit must occur within twenty eight (28) days of your notification to us) and give us full access in order that we may fully investigate the complaint. You will be provided with a written response to your dispute or claim within twenty eight (28) days of the date of the inspection.

If you are not satisfied with our response you must within twenty one (21) days of your receipt of our written response refer the matter to a mediator nominated by us from the institute of arbitrators and mediators of Australia. The cost of the mediator will be borne equally by both parties or as agreed as part of the mediated settlement.

Should the dispute or claim not be resolved by mediation then the dispute or claim will proceed to arbitration. The institute of arbitrators and mediators of Australia will appoint an arbitrator who will hear and resolve the dispute. The arbitration, subject to any directions of the arbitrator, will proceed in the following manner:

A) the parties must submit all written submissions and evidence to the arbitrator within twenty one (21) days of the appointment of the arbitrator; and

B) the arbitration will be held within twenty one (21) days of the arbitrator receiving the written submissions.

The arbitrator will make a decision determining the dispute or claim within twenty one (21) of the final day of the arbitration. The arbitrator may, as part of his determination, determine what costs, if any, each of the parties are to pay and the time by which the parties must be paid any settlement or costs. The decision of the arbitrator is final and binding on both parties. Should the arbitrator order either party to pay any settlement amount or costs to the other party but not specify a time for payment then such payment shall be made within twenty one (21) days of the order.

In the event you do not comply with the above complaints procedure and commence litigation against us then you agree to fully indemnify us against any awards, costs, legal fees and expenses incurred by us in having your litigation set aside or adjourned to permit the foregoing complaints procedure to complete.

11. Complaint investigation: In the event any litigation is started as a result of the inspection and/or report, you indemnify us against any legal fees and expenses incurred where you have not first allowed us the opportunity to visit the property to investigate the complaint and provide you with a written response within 28 days.

2. Visual Timber Pest Inspection Report

Important Information

For complete and accurate information please refer to the attached complete visual timber pest report, provided in accord with AS 4349.3-2010

2.1 Brief Description of Areas Inspected

NOTE

Only structures, fences & or trees within 30m of the building but within the property boundaries were inspected.

The areas inspected were

Please refer to the Inspected and restricted areas in the Building Inspection section of this report.

2.2 Areas Not Inspected

Please Note

No inspection was made, and no report is submitted, of inaccessible areas. These include, but may not be limited to, cavity walls, concealed frame timbers behind tiled walls or other coverings such as Gyprock, Fibrous cement sheeting and any paneled/cladded wall, eaves, flat roofs, fully enclosed patios sub-floors, soil concealed by concrete floors, fireplace hearths, wall linings, landscaping, rubbish, floor coverings, furniture, pictures, appliances, stored items, insulation, hollow blocks/posts, etc. The inspection did not include obstructed areas, not readily accessible and inaccessible areas at the time in inspection which were inaccessible, not readily accessible or obstructed areas at the time of inspection. Locked and restricted areas were not inspected. Removing furnishings and obstructions which may be concealing evidence of defects is outside the scope of this inspection. It is strongly recommended that all obstructions be removed and full access be provided as defects may exist in these areas.

Unable to Inspect

No inspection made or report submitted to any concealed timber frames.

Please refer to the Inspected and restricted areas in the Building Inspection section of this report.

2.4 House furnishings

Please Note

Where a property is furnished at the time of the inspection then you must understand that the furnishings and stored goods may be concealing evidence of timber pest activity. This evidence may only be revealed when the property is vacated. A further inspection of the vacant property is strongly recommended in this case no inspection was made and no report is submitted, of inaccessible areas. If a complete inspection of the areas in the dwelling was not possible, termite activity and/or damage may exist in these areas and nothing in this report implies that any inaccessible or partly inaccessible areas or sections of the property being inspected by me on the date of the inspection were not, or have not been infested by timber pests. Accordingly, this report does not report on inaccessible areas. This includes but may not be limited to concealed frame timbers, eaves, areas concealed by concrete floors, wall linings, soil, landscaping, rubbish, floor coverings (carpet lino etc.), Furniture, pictures, appliances (dishwashers, refrigerators, washing machines, ovens, microwave ovens, heating and cooling units etc.), Stored items (clothes on floor, boxes on floor and against walls, beds against walls and the like), insulation, hollow blocks/columns/posts/poles or other architectural hollow structures. Furnishings found at this dwelling were not inspected and do not form part of this inspection.

Was the dwelling Furnished

The dwelling was fully furnished.

2.5 Areas of Visual Inspection obstructed and why

Areas Obstructed

Where present carpet conceals damage to the underside, owner's possessions, items in cupboards & furniture present throughout the building, which is preventing a thorough inspection from being undertaken. You should be aware that furnishings and/or owners possessions may be concealing evidence of timber pests and defects, which may only be revealed when items are removed or moved. It is strongly recommended that full access be gained as it could be harbouring timber pest activity, pest damage or defects.

There is insulation, present in the roof space/void. This is preventing a full inspection from being undertaken. It is strongly recommended that full access be gained as it could be harbouring timber pest activity and/or damage.

There is sarking present in the roof space/void. This is preventing a full inspection from being undertaken. It is strongly recommended that full access be gained as it could be harbouring timber pest activity and/or damage.

Regardless of whether any obstruction were listed, the client acknowledges that no inspection was made, and no report is submitted, of obstructed areas. These include, but may not be limited to, cavity walls, concealed frame timbers behind tiled walls or other coverings such as Gyprock, Fibrous cement sheeting and any paneled/cladded wall, eaves, flat roofs, fully enclosed patios sub-floors, soil concealed by concrete floors, fireplace hearths, wall linings, landscaping, rubbish, floor coverings, furniture, pictures, appliances, stored items, insulation, hollow blocks/posts, etc. The inspection did not include obstructed areas, not readily accessible and inaccessible areas at the time in inspection which were inaccessible, not readily accessible or obstructed areas at the time of inspection. Removing furnishings and obstructions which may be concealing evidence of defects is outside the scope of this inspection. It is strongly recommended that all obstructions be removed and full access be provided as defects may exist in these areas.

Please Note

Please note since a complete inspection of the above areas was not possible, timber pest activity and/or damage may exist in these areas.

2.6 High Risk Areas where access should be gained

Areas of High Risk requiring Inspection

Areas of high risk area(s) to which access should be gained, or fully gained, since they may show evidence of timber pests or damage:

High Risk Areas are

The slab edge has been covered by paths/paving/garden vegetation or soil. Slab edges where the slab and base brick courses join is an area where termite access can easily be obtained. This provides undetected termite entry and the degree of risk of termite infestation is high. It is essential that at least 75 mm of the slab edge be exposed so inspections can be made for any termite activity/entry between the base brick and the slab.

Important: Where a complete inspection of the above areas was not possible, timber pest activity and/or damage may exist in these areas, further inspections are strongly recommended to areas where reasonable access is unavailable, obstructed or restricted or a high risk of possible timber pests and/or damage exists.

Timber Fences.

The garage.

Undetected Termite Activity Risk Assessment

Due to restrictions and obstructions to the dwelling the level of undetected termite activity is considered Average.

Please refer to section 4 of the terms and conditions outlined in this report.

The following further inspections are recommended

Furnished properties: Where a property is furnished at the time of the inspection the furnishings and stored goods may be concealing evidence of Timber Pest Activity. This evidence may only be revealed when the property is vacated. A further inspection of the vacant property is strongly recommended in this case.

Note: No inspection was made, and no report is submitted, of obstructed areas. These include, but may not be limited to, cavity walls, concealed frame timbers behind tiled walls or other coverings such as Gyprock, Fibrous cement sheeting and any panelled/cladded walls.



TIMBER PEST FINDINGS

3. Subterranean Termites

Were Active or Live Termites Visible

No. Of the visible and accessible areas inspected, there were no visible termites found at the time of the inspection.

3.1 Termite Nests

Was a Termite Nest Found

No termite nests found at time of inspection.

3.2 Subterranean Termite Damage or workings

Any workings or damage found

No. Of the visible and accessible areas inspected, no termite working or timber damage found at the time of the inspection.

We claim no expertise in building and if any evidence or damage has been reported then you must have a building expert determine the full extent of damage and the estimated cost of repairs or timber replacement (See Terms & Limitations)

Please Note

Where evidence of termite activity was found in the grounds then the risk to buildings is extremely high. A treatment to eradicate the termites and to protect the building(s) should be carried out in the first instance.

Extent Of Damage

We claim no expertise in building and if any evidence or damage has been reported then you must have a building expert determine the full extent of damage and the estimated cost of repairs or timber replacement (See Terms & Limitations).

If damage is visible does it present a safety risk

Important Note: Where a Major Safety Hazard is identified above, it must be attended to and/or rectified to avoid the possibility of personal injury &/or death. **VERY Important:** If live termites or any evidence of termite workings or damage was reported above within the building(s) or in the ground and fences then it must be assumed that there may be concealed termite activity and/or timber damage. This concealed activity or damage may only be found when alterations are carried out such as when wall linings, cladding or insulation are removed or if you arrange for an invasive inspection. We claim no expertise in structural engineering or building. We strongly recommend that you have a qualified person such as a Builder, Engineer, Architect or other qualified expert in the building trade determine the full extent of the damage, if any. This may require an invasive inspection. We take no responsibility for the repair of any damage whether disclosed by this report or not. (See Terms & Limitations). Where visual evidence of termite workings and/or damage is reported above, but no live termites were present at the time of inspection, you must realize that it is possible that termites are still active in the immediate vicinity and the termites may continue to cause further damage. It is not possible, without benefit of further investigation and a number of inspections over a period of time, to ascertain whether any infestation is active or inactive. Active termites may simply have not been present at the time of inspection due to a prior disturbance, climatic conditions, or they may have been utilizing an alternative feeding source. Continued, regular, inspections are essential. Unless written evidence of a termite protection program in accord with "Australian Standard 3660" with ongoing inspections is provided, you must arrange for a treatment in accord with "Australian Standard 3660" to be carried out immediately to reduce the risk of further attack. General remarks: A more thorough INVASIVE INSPECTION is available (refer to section 9 of the terms and conditions). Where any current visible evidence of Timber Pest activity is found it is strongly recommended that a more invasive inspection be performed. Trees and stumps on the property with a diameter more than 100mm have been visually inspected for evidence of termite activity to a height of 2m where access was possible and practical. It is very difficult, and generally impossible to locate termite nests since they are underground and evidence in trees is usually well concealed. We therefore strongly recommend that you arrange to have trees test drilled for evidence of termite nests.

3.3 Any Evidence of a Previous Termite Treatment

Any Evidence of previous Treatments Found

No, there was no visible evidence or a previous termite treatment was located at the property.

Warning

Warning: If evidence of drill holes in concrete or brickwork or other signs of a possible previous treatment are reported then the treatment was probably carried out because of an active termite attack. Extensive structural damage may exist in concealed areas. You should have an invasive inspection carried out and have a builder determine the full extent of any damage and the estimated cost of repairs as the damage may only be found when wall linings etc. are removed. Normally if a termite treatment has been carried out then a durable notice should be located in the meter box indicating the type of termite shield system, treated zone or combination has been installed.

3.4 Durable Notice

Was a Treatment Notice Found

No, a durable notice was not found during the inspection.

Please Note

This firm can give no assurances with regard to work that may have been previously performed by other firms. You should obtain copies of all paperwork and make your own inquiries as to the quality of the treatment, when it was carried out and warranty information. In most cases you should arrange for a treatment in accord with Australian Standard 3660 be carried out to reduce the risk of further attack.

3.5 Timber Fungal Decay - Rot

Evidence of Wood Decay Fungi -Rot

No

Extent of Damage Caused by Rot

If any evidence of fungal decay or damage is reported you should consult a building expert determine the full extent of damage and the estimated cost of repairs or timber replacement (see terms & limitations).

Does the damage present a Major Safety Hazard

Important Note: Where a Major Safety Hazard is identified above, it must be attended to and/or rectified to avoid the possibility of personal injury & or death. We claim no expertise in building and if any evidence of fungal decay or damage is reported you should consult a building expert to determine the full extent of damage and the estimated cost of repairs or timber replacement.

3.6 Chemical Delignification

Was there any visible evidence of chemical delignification?

No evidence of chemical delignification was seen at the time of inspection.

3.7 Borer Findings

Borer Information

Borer information: *Lyctus brunneus* (powder post beetle) is not considered a significant pest of timber. Damage is confined to the sapwood so treatment or timber replacement is not usually required. However you should have a building expert investigate if any timber replacement is required. *Anobium punctatum* (furniture beetle) and *calymmaderus incisus* (Queensland pine beetle) must always be considered active unless proof of treatment is provided because one cannot determine conclusively if activity has ceased. Total timber replacement of all susceptible timbers is recommended. An alternate choice is treatment however, the evidence and damage will remain and the treatment may need to be carried out each year for up to three years.

Was Visible Evidence of Borer Damage Found

No evidence of borer damage was found at the time of inspection.

Please Note

If any evidence or damage has been reported then you must have a building expert determine the full extent of damage and the estimated cost of repairs or timber replacement (see terms & limitations). Borer activity is usually determined by the presence of exit holes and/or frass. Since a delay exists between the time of initial infestation and the appearance of these signs, it is possible that some borer activity may exist that is not discernible at the time of inspection.

3.8 Borer Recommendations

Borer Recommendations

No treatment recommended at this stage.

Note: Only *lyctus* borer/powder post borer, pin-hole borer and furniture beetle presence is inspected.

CONDUCTIVE CONDITIONS

4. Conductive Conditions to Timber Pests

Water leaks

There was water leakage detected during the inspection from the hot water overflow. This should be diverted away from the dwellings walls or into a drain.

Please Note

Water leaks, especially in or into the sub-floor or against the external walls ie: Leaking taps, water tanks or downpipes and or guttering, increases the likelihood of termite attack. Leaking showers or leaks from other wet areas also increase the likelihood of concealed termite attack. These conditions are also conducive to borer activity and wood decay. If any leaks were reported then you must have a qualified plumber or other building expert to determine the full extent of damage and the estimated cost of repairs prior to the contract of sale becoming binding.

4.1 Hot Water Unit Overflow

Please Note

Hot water services and air conditioning units which release water alongside or near to building walls need to be connected to a drain (if this is not possible then their water outlet needs to be piped several meters away from the building) as the resulting wet area is highly conducive to termites.

Water tanks should not leak and the overflow should be adequately connected to storm water. A plumber should be engaged if the water tank overflow is not connected to storm water.

Was the overflow sufficiently drained

No. Divert hot water overflow away from the building perimeter.

Was the Air Conditioner Sufficiently Drained

No - Divert A/C overflow away from the building perimeter.

4.2 Moisture Readings

Was there any Excessive Moisture Readings

At the time of the inspection, our electronic moisture meter readings were normal.

Please Note

High moisture readings can be caused by any one of the following: Poor ventilation, ineffective drainage, leaking pipes, leaking roofs, defective flashing or by concealed termite activity. The areas of high moisture should be investigated by way of an invasive inspection. If high moisture was reported then you must have a building expert investigate the moisture and its cause and determine the full extent of damage and the estimated cost of repairs prior to contracts becoming binding.

Equipment Of Moisture detection used

Termatrac.

If high moisture was reported then you must have a building expert investigate the moisture and its cause and determine the full extent of damage and the estimated cost of repairs prior to contracts becoming binding.

4.3 Sub Floor Ventilation

Sub-floor Ventilation is Generally

Not applicable - Slab construction.

4.4 Slab Edge Exposure

Is the Slab Edge adequately Exposed

No. Slab edge should be exposed a minimum of 75mm.

4.5 Weep Holes and Sub Floor Vents

Were the weep holes Clear of debris

Yes. The weep holes were clear of debris at the time of inspection.

5. Ant Capping and Termite Shields

The Termite Shields Appear To Be

Not applicable

Please Note

Termite shields (Ant Caps) should be in good order and condition so termite workings are exposed and visible. This helps stop termites gaining undetected entry. Missing, damaged or poor shields increase the risk of termite infestation. If considered inadequate a builder or other building expert should be consulted for further advice and recommendation.

6. Areas Found Conducive To Termite Infestation

Conducive Areas Requiring Amendments

Leaking Air conditioning compressor creating conducive conditions.

Hot water unit overflow not connected to drain. This provides conducive conditions for termite infestation.

The slab edge is not exposed. The slab edge must be exposed at least 75mm so that a thorough inspection can be conducted for any termite infestation/entry points.

7. Environmental Conditions

Are Trees Close to Home

No.

8. Thermal Imaging Results

Observation

Not applicable to this inspection as no thermal imaging device was requested.



OVERALL ASSESSMENT

9. Overall Assessment of Property

Please Note

Where or if there has been evidence of live termites or termite damage or termite workings (mudding) found in the building(s) then the risk of a further attack is extremely high. Where evidence of live termites or termite damage or termite workings was found in the grounds but not in the buildings then the risk to buildings must be reported as high to extremely high.

Degree of Risk of Termite Infestation is

The overall degree of risk of timber pest infestation to this property appears to be high.

The overall degree of risk of timber pest infestation is a subjective assessment by the inspector at the time of the inspection taking into account many factors which include but are in no way limited to location and proximity to bush land and trees, the presence of evidence of timber pest damage or activity close to the inspected structure or within the inspected structure, conducive conditions that raise the potential of timber pest attack such as timbers in contact with soil, inaccessible areas, slab on ground construction etc, or other factors that in the inspectors opinion, raise the risk of future timber pest attack. It should be noted that even if a risk factor is high, this is not meant to deter a purchaser from purchasing the property, it is just to make them aware that increased vigilance is warranted and any recommendations regarding reducing conducive conditions or frequency of inspections should be headed by any property owner. Often, by reducing or eliminating some of the conducive conditions, the risk factor may be lowered.

10. Subterranean Termite Treatment Recommendation

Treatment Recommendation

A management program in accord with AS 3660 to protect against subterranean termites is considered to be essential.

11. Future Inspections

Future Inspections

Future inspections: As 3660 Recommends that inspections be carried out at intervals no greater than 12 months and where timber pest "pressure" is greater, this interval should be shortened. Inspections will not stop timber pest infestations; however, the damage which may be caused will be reduced when the infestation is found at an early stage. Due to the degree of risk of subterranean termite infestation noted above and all other findings of this report, we strongly recommend that a full inspection and written report in accord with as 4349.3 or as 3660 be conducted with in the time frame proposed below.

Recommended Inspection Intervals

12 Months.

12. General Remarks

Terms And Conditions

IMPORTANT INFORMATION

In relying upon this report you should read and understand the following important information. It will help explain what is involved in a timber pest inspection, the difficulties faced by a timber pest inspector and why it is not possible to guarantee that a property is free of timber pests. It also details important information about what you can do to help protect your property from timber pest attack. This information forms an integral part of the report.

1.0 DEFINITIONS: For the purpose of this inspection, the definitions below apply.

1.1 Active - The presence of live timber pests at the time of inspection.

1.2 Inactive - The absence of live timber pests at the time of inspection.

Note: Where visual evidence of inactive termite workings and/or damage is located, it is possible that termites are still active in the immediate vicinity and the termites may continue to cause further damage. It is not possible, without the benefit of further investigation and inspections over a period of time, to ascertain whether any infestation is active or inactive. Continued, regular inspections are essential.

1.3 Minor - Damage that is superficial and does not appear to require any timber replacement or repairs to be carried out.

1.4 Moderate - Damage that is more than surface damage and it is likely to necessitate timber repairs with possible replacement (if more economical or for aesthetic reasons) to be carried out.

1.5 Severe - Damage that appears to be significant and the integrity or serviceability of timbers may be impaired. Usually timbers will have to be repaired and/or replaced.

1.6 Timber Damage - It is essential that any timber damage noted in the report be referred to a suitably qualified building professional and obtain a special purpose building report relating to the extent of the timber damage. The full extent of damage may only be revealed by invasive inspection methods including probing and the removal of lining materials. This type of invasive inspection has not been carried out and you should understand that the extent and/or severity of timber damage may be found to increase significantly on such an invasive inspection. The references contained within this report that may refer to the extent of timber damage have only been included to assist in determining treatment specifications and not to quantify the damage and must not be relied upon to determine the costs of repair or replacement.

2.0 REASONABLE ACCESS: Only areas where reasonable access was available were inspected. The Australian Standard AS3660 refers to AS4349.3-2010 which defines reasonable access. Access will not be available where there are safety concerns, or obstructions, or the space available is less than the following:

ROOF SPACE - the dimensions of the access hole must be at least 500mm x 400mm, and, reachable by a 3.6M ladder, and, there is at least 600mm x 600mm of space to crawl.

SUBFLOOR - the dimensions of the access hole must be at least 500mm x 400mm and, there is at least 400mm of space to crawl beneath the lowest part of any bearer and at least 500mm below any concrete member.

ROOF EXTERIOR - must be accessible by a 3.6M ladder placed safely on the ground.

Reasonable access does not include the use of destructive or invasive inspection methods. Nor does reasonable access include cutting or making access traps, or moving heavy furniture or stored goods.

3.0 A MORE INVASIVE AND PHYSICAL INSPECTION IS AVAILABLE AND RECOMMENDED: This inspection was a visual inspection only. As detailed above, there are many limitations to this visual inspection. With the written permission of the owner of the premises we will perform a more invasive physical inspection that involves moving or lifting of insulation, moving stored items, furniture or foliage during the inspection. We will physically touch, tap, test and where necessary force/gouge suspected accessible timbers. We will gain access to areas, where physically possible and considered practical and necessary, by way of cutting traps and access holes. This style of report is available by ordering with several days notice. Inspection time for this report will be greater than for a visual inspection. It involves disruption in the case of an occupied property, and some permanent marking is likely. You must arrange for the written permission of the owner and must acknowledge all the above information and confirm that our firm will not be held liable for any damage caused to the property. Price available on request.

4.0 CONCRETE SLAB HOMES (Part or full slab) Homes constructed on concrete slabs pose special problems with respect to detecting termite attack. If the edge of the slab is concealed by garden beds, lawns, paths, pavers or any other obstructions then it is possible for termites to effect concealed entry into the property. They can then cause extensive damage to concealed framing timbers before being detected. Even the most experienced inspector may be unable to detect their presence due to concealment by wall linings or other obstructions. Only when the termites attack timbers in the roof void, which may be concealed by insulation, or some other visible timbers, can their presence be detected. Where termite damage is located in the roof it should be expected that concealed framing timbers (if present) may be extensively damaged. With a concrete slab home (part or full) it is imperative that you expose the edge of the slab. This may involve the excavation of soil or the complete removal of garden beds, paths, pavers or other features which concealed the slab edge. It is recommended that at least 75 millimetres of the slab edge above ground level remain exposed at all times to facilitate the detection of termite entry. Weep holes must also be kept free of obstructions at all times.

5.0 EVIDENCE OF TERMITE DAMAGE: Where evidence of termite damage was noted in any structure or on the grounds of the property, you must understand that termite damage or activity may exist in concealed areas. Termites are secretive by nature and they will often temporarily desert their workings to later return. As damage or activity may exist in concealed or inaccessible areas, a further INVASIVE INSPECTION is strongly recommended, see Section 3.0 - Further Invasive Inspections. Additionally, regular inspections are strongly recommended at intervals not exceeding 12 monthly and more frequently if recommended.

6.0 SUBTERRANEAN TERMITES: No Property is safe from termites! Termites are the cause of the greatest economic losses of timber in service in Australia. Independent data compiled by State Forests shows 1 in every 4 homes are attacked by termites at some stage in their life. Australia's subterranean termite species are the most destructive timber pests in the world.

How termites attack your home! The most destructive species live in large underground nests containing several hundred thousand timber-destroying insects. The problem arises when a nest matures near your home. Your home provides natural shelter and a food source for the termites. The gallery system of a single termite colony may exploit food sources over as much as one hectare, with individual galleries extending up to 50 metres or more to enter your home. Concrete slabs do not act as a barrier as termites can penetrate cracks through the slab or over the slab edge and once in contact with the timber they can excavate it often leaving only a thin veneer on the outside. If left undiscovered the economic species can cause many thousands of dollars damage and can be costly to treat.

7.0 BORERS OF DRY SEASONED TIMBERS: Borers are the larval stage of various species of beetle. The adult beetles lay their eggs within the timber. The eggs hatch out into larvae that bore through the timber. The larvae may reside totally concealed within the timber for a period of several years before passing into a dormant pupal stage. Within the pupal case they metamorphose (change) into the adult beetle that cuts a hole in the outer surface of the timber to emerge, mate and lay further eggs to continue the cycle. It is only through the presence of these emergence holes that their presence can be detected. Refer to this report (if applicable) for further information.

Anobium punctatum borer (furniture beetle). Commonly attack softwood flooring timbers, shelving timbers and timber panelling. They have the potential to cause severe timber damage if left untreated for many years. Attack by this beetle is usually observed in timbers that have been in service for 10 to 20 years or more.

Lyctus brunneus borer (powder post beetle). These borers only attack the sapwood of certain susceptible species of hardwood timber. Since it is a requirement that the structural timbers contain no more than 25% Lyctus susceptible sapwood, these borers are not normally associated with structural damage. Replacement of affected timbers is not recommended and treatment is not approved or required.

Queensland Pine Beetle borer. These borers commonly attack flooring and wall timbers. It is not possible to determine with absolute certainty whether activity exists without destruction of the timbers. We therefore recommend that it would be prudent to assume that current borer activity is present unless written evidence is available to indicate that the property has been recently treated in respect to this borer. Replacement of affected timbers is always preferred as a long term solution since, in the event of selling the property in the future it is probable that an Inspector will report the borers as active (see above). A chemical treatment to control re-infestation may be considered a less effective and lower cost option. This treatment is applied to the underside of all soft pine flooring timbers and to other affected timbers as required.

Non-Commercial borers Are those borers that attack dead trees, logs and tree stumps. These borers are generally not considered to be a threat to timber in service (timber used in the buildings). No treatment is necessary for this species.

8.0 FUNGAL DECAY (WOOD ROT) Fungal decay is more commonly known as wood rot. Many problems with timber pests are related to excessive moisture because Termites and wood rot both require heat and moisture to survive. Small sections of minor decay can often be removed and the resulting hole filled with "Builders filler".

Areas of moderate decay will require sections of timber to be replaced. Where there is severe fungal decay the entire affected timber member should be replaced, preferably with treated hardwood.

Oregon timber is highly susceptible to Fungal Decay and should be kept well painted. Oregon was once used extensively to construct pergolas and carports and the like. The use of Oregon in external applications is generally considered to be unsuitable.

9.0 MOULD: Mildew and non-wood decay fungi is commonly known as Mould and is not considered to be a timber pest. However, Mould and their spores may cause health and allergic reactions such as asthma and dermatitis in some people. No inspection for Mould was carried out at the property and no report on the presence or absence of Mould is provided.

If Mould is noted as present within the property and you are concerned as to the possible health risk resulting from its presence then you should seek advice from your Local Council, State or Commonwealth Health Department or a qualified expert such as an Industry Hygienist.

10.0 COMPLAINTS PROCEDURE: In the event of any dispute or claim arising out of, or relating to the Inspection or the Report, You must notify Us as soon as possible of the dispute or claim by email, fax or mail. You must allow Us (which includes persons nominated by Us) to visit the property (which visit must occur within twenty eight (28) days of your notification to Us) and give Us full access in order that We may fully investigate the complaint. You will be provided with a written response to your dispute or claim within twenty eight (28) days of the date of the inspection.

If You are not satisfied with our response You must within twenty one (21) days of Your receipt of Our written response refer the matter to a Mediator nominated by Us from the Institute of Arbitrators and Mediators of Australia. The cost of the Mediator will be borne equally by both parties or as agreed as part of the mediated settlement.

In the event You do not comply with the above Complaints Procedure and commence litigation against Us then You agree to fully indemnify Us against any awards, costs, legal fees and expenses incurred by Us in having your litigation set aside or adjourned to permit the foregoing Complaints Procedure to complete.

CONTACT THE INSPECTOR: Please feel free to contact the inspector who carried out this inspection. Often it is very difficult to fully explain situations, problems, access difficulties, building faults, timber pest activity and damage or their importance in a manner that is readily understandable by the reader. Should you have any difficulty in understanding anything contained within this report then you should immediately contact the inspector and have the matter explained to you. If you have any questions at all or require clarification then contact the inspector prior to acting on this report.

The Inspection and Report was carried out by: Michael Lotz

Contact the Inspector on: 0424286272

For and on Behalf of: Naraic Building & Pest Inspections Pty Ltd

